

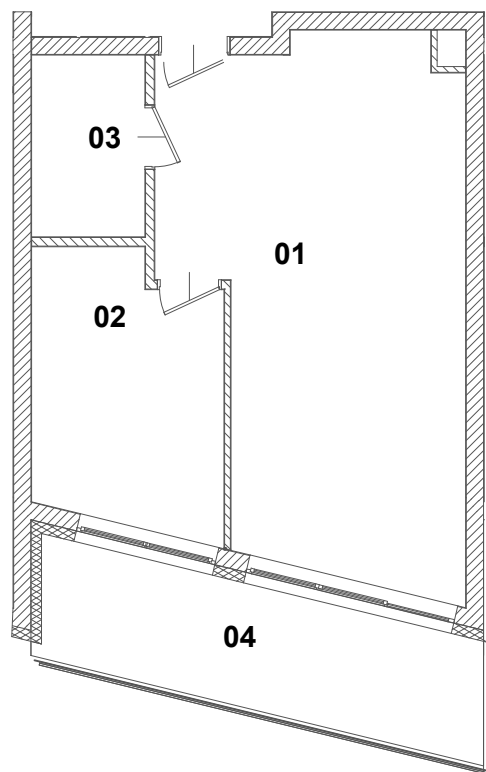

LOKAL MIESZKALNY

**NR 01.10**

I PIĘTRO



**ZESTAWIENIE POWIERZCHNI**

1. POKÓJ Z ANEKSEM KUCHENNYM	27,91m <sup>2</sup>
2. POKÓJ	9,73m <sup>2</sup>
3. ŁAZIENKA	4,05m <sup>2</sup>
SUMA	41,69m <sup>2</sup>
4. BALKON	11,09m <sup>2</sup>

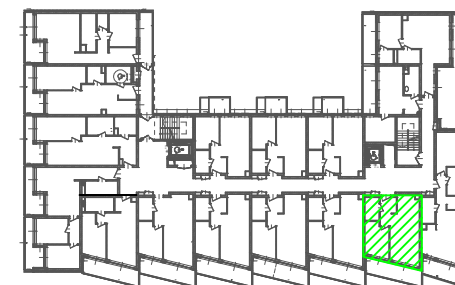

SKALA 1:100