

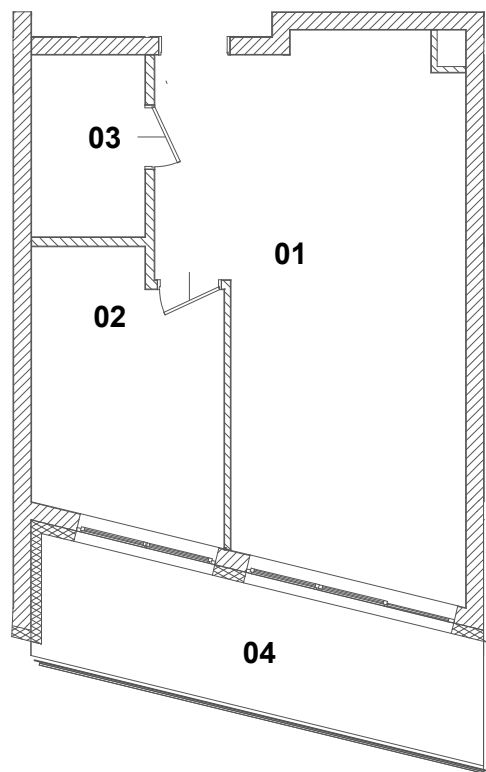

LOKAL MIESZKALNY

NR 03.07

III PIĘTRO



ZESTAWIENIE POWIERZCHNI

1. POKÓJ Z ANEKSEM KUCHENNYM	27,85m ²
2. POKÓJ	9,80m ²
3. ŁAZIENKA	4,01m ²
SUMA	41,66m ²
4. BALKON	11,09m ²

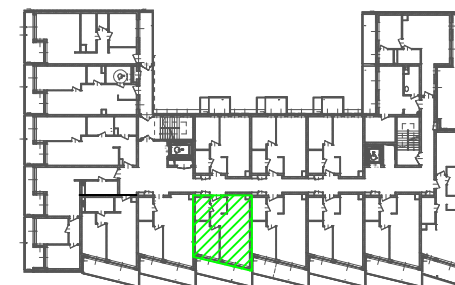

SKALA 1:100