

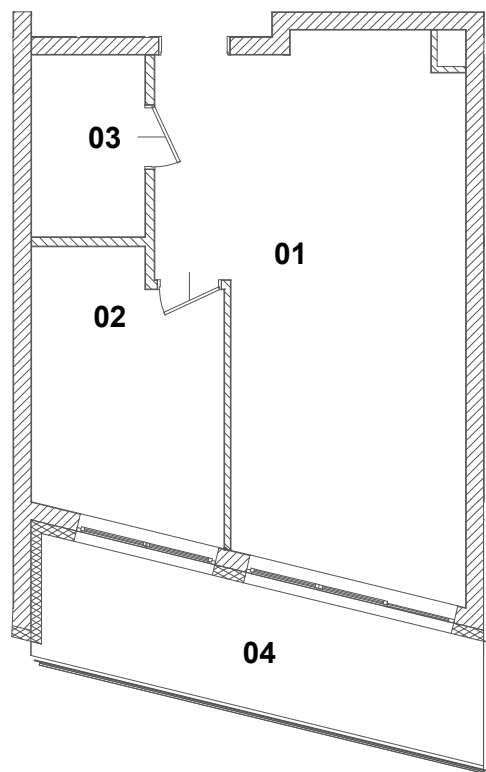

LOKAL MIESZKALNY

NR 03.08

III PIĘTRO



ZESTAWIENIE POWIERZCHNI

1. POKÓJ Z ANEKSEM KUCHENNYM	27,78m ²
2. POKÓJ	9,78m ²
3. ŁAZIENKA	4,01m ²
SUMA	41,57m ²
4. BALKON	11,09m ²

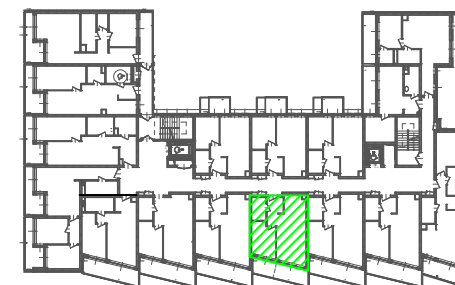

SKALA 1:100