

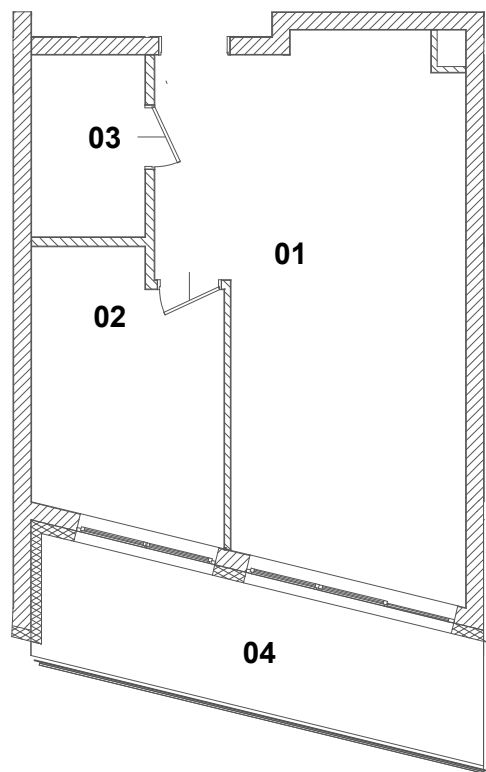

LOKAL MIESZKALNY

**NR 01.07**

I PIĘTRO



**ZESTAWIENIE POWIERZCHNI**

1. POKÓJ Z ANEKSEM KUCHENNYM	27,98m <sup>2</sup>
2. POKÓJ	9,80m <sup>2</sup>
3. ŁAZIENKA	4,06m <sup>2</sup>
SUMA	41,84m <sup>2</sup>
4. BALKON	11,09m <sup>2</sup>

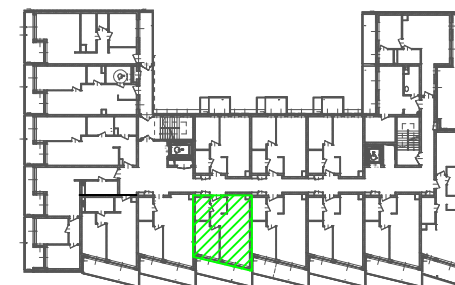

SKALA 1:100